

Inspiron 15

7000 Series

Service Manual

Computer Model: Inspiron 15-7568
Regulatory Model: P55F
Regulatory Type: P55F002



Notes, cautions, and warnings



NOTE: A NOTE indicates important information that helps you make better use of your computer.



CAUTION: A CAUTION indicates either potential damage to hardware or loss of data and tells you how to avoid the problem.



WARNING: A WARNING indicates a potential for property damage, personal injury, or death.

Copyright © 2015 Dell Inc. All rights reserved. This product is protected by U.S. and international copyright and intellectual property laws. Dell™ and the Dell logo are trademarks of Dell Inc. in the United States and/or other jurisdictions. All other marks and names mentioned herein may be trademarks of their respective companies.

2015 - 09

Rev. A00

Contents

Before working inside your computer.....	8
Before you begin	8
Safety instructions.....	8
Recommended tools.....	9
After working inside your computer.....	10
Removing the base cover.....	11
Procedure.....	11
Replacing the base cover.....	12
Procedure.....	12
Removing the battery.....	13
Prerequisites.....	13
Procedure.....	13
Replacing the battery.....	15
Procedure.....	15
Post-requisites.....	15
Removing the memory module.....	16
Prerequisites.....	16
Procedure.....	16
Replacing the memory module.....	18
Procedure.....	18
Post-requisites.....	19

Removing the hard drive.....	20
Prerequisites.....	20
Procedure.....	20
Replacing the hard drive.....	23
Procedure.....	23
Post-requisites.....	23
Removing the coin-cell battery.....	24
Prerequisites.....	24
Procedure.....	24
Replacing the coin-cell battery.....	26
Procedure.....	26
Post-requisites.....	26
Removing the wireless card.....	27
Prerequisites.....	27
Procedure.....	27
Replacing the wireless card.....	29
Procedure.....	29
Post-requisites.....	30
Removing the keyboard daughter-board.....	31
Prerequisites.....	31
Procedure.....	31
Replacing the keyboard daughter-board.....	33
Procedure.....	33
Post-requisites.....	33

Removing the speakers.....	34
Prerequisites.....	34
Procedure.....	34
Replacing the speakers.....	36
Procedure.....	36
Post-requisites.....	36
Removing the touch pad.....	37
Prerequisites.....	37
Procedure.....	37
Replacing the touch pad.....	43
Procedure.....	43
Post-requisites.....	43
Removing the fan.....	45
Prerequisites.....	45
Procedure.....	45
Replacing the fan.....	48
Procedure.....	48
Post-requisites.....	48
Removing the heat sink.....	49
Prerequisites.....	49
Procedure.....	49
Replacing the heat sink.....	51
Procedure.....	51
Post-requisites.....	51



Removing the power-adapter port.....	52
Prerequisites.....	52
Procedure.....	52
Replacing the power-adapter port.....	54
Procedure.....	54
Post-requisites.....	54
Removing the power and volume-buttons board.....	55
Prerequisites.....	55
Procedure.....	55
Replacing the power and volume-buttons board.....	58
Procedure.....	58
Post-requisites.....	58
Removing the I/O board.....	59
Prerequisites.....	59
Procedure.....	59
Replacing the I/O board.....	61
Procedure.....	61
Post-requisites.....	61
Removing the display assembly.....	62
Prerequisites.....	62
Procedure.....	62
Replacing the display assembly.....	65
Procedure.....	65
Post-requisites.....	65

Removing the system board.....	67
Prerequisites.....	67
Procedure.....	67
Replacing the system board.....	71
Procedure.....	71
Post-requisites.....	72
Entering the Service Tag in the BIOS setup program.....	72
Removing the keyboard.....	73
Prerequisites.....	73
Procedure.....	73
Replacing the keyboard.....	76
Procedure.....	76
Post-requisites.....	76
Removing the computer base.....	77
Prerequisites.....	77
Procedure.....	77
Replacing the computer base.....	79
Procedure.....	79
Post-requisites.....	79
Flashing the BIOS.....	80
Getting help and contacting Dell.....	81
Self-help resources.....	81
Contacting Dell.....	82

Before working inside your computer

 **NOTE:** The images in this document may differ from your computer depending on the configuration you ordered.







Before you begin

- 1 Save and close all open files and exit all open applications.
 - 2 Shut down your computer.
 - Windows 10: Click or tap **Start** →  **Power** → **Shut down**.
 - Windows 8.1: On the **Start** screen, click or tap the power icon  → **Shut down**.
 - Windows 7: Click or tap **Start** → **Shut down**.
-  **NOTE:** If you are using a different operating system, see the documentation of your operating system for shut-down instructions.
- 3 Disconnect your computer and all attached devices from their electrical outlets.
 - 4 Disconnect all cables such as telephone cables, network cables and so on, from your computer.
 - 5 Disconnect all attached devices and peripherals, such as keyboard, mouse, monitor, and so on, from your computer.
 - 6 Remove any media card and optical disc from your computer, if applicable.

Safety instructions

Use the following safety guidelines to protect your computer from potential damage and ensure your personal safety.

 **WARNING:** Before working inside your computer, read the safety information that shipped with your computer. For more safety best practices, see the Regulatory Compliance home page at www.dell.com/regulatory_compliance.

-  **WARNING:** Disconnect all power sources before opening the computer cover or panels. After you finish working inside the computer, replace all covers, panels, and screws before connecting to the power source.
-  **CAUTION:** To avoid damaging the computer, ensure that the work surface is flat and clean.
-  **CAUTION:** To avoid damaging the components and cards, handle them by their edges and avoid touching pins and contacts.
-  **CAUTION:** You should only perform troubleshooting and repairs as authorized or directed by the Dell technical assistance team. Damage due to servicing that is not authorized by Dell is not covered by your warranty. See the safety instructions that shipped with the product or at www.dell.com/regulatory_compliance.
-  **CAUTION:** Before touching anything inside your computer, ground yourself by touching an unpainted metal surface, such as the metal at the back of the computer. While you work, periodically touch an unpainted metal surface to dissipate static electricity, which could harm internal components.
-  **CAUTION:** When you disconnect a cable, pull on its connector or on its pull tab, not on the cable itself. Some cables have connectors with locking tabs or thumb-screws that you must disengage before disconnecting the cable. When disconnecting cables, keep them evenly aligned to avoid bending any connector pins. When connecting cables, ensure that the ports and connectors are correctly oriented and aligned.
-  **CAUTION:** Press and eject any installed card from the media-card reader.

Recommended tools

The procedures in this document may require the following tools:

- Phillips screwdriver
- Plastic scribe

After working inside your computer



CAUTION: Leaving stray or loose screws inside your computer may severely damage your computer.

- 1 Replace all screws and ensure that no stray screws remain inside your computer.
- 2 Connect any external devices, peripherals, and cables you removed before working on your computer.
- 3 Replace any media cards, discs, and any other parts that you removed before working on your computer.
- 4 Connect your computer and all attached devices to their electrical outlets.
- 5 Turn on your computer.

Removing the base cover

⚠ WARNING: Before working inside your computer, read the safety information that shipped with your computer and follow the steps in [Before working inside your computer](#). After working inside your computer, follow the instructions in [After working inside your computer](#). For more safety best practices, see the Regulatory Compliance home page at www.dell.com/regulatory_compliance.

Procedure

- 1 Close the display and turn the computer over.
- 2 Remove the screws that secure the base cover to the computer base.
- 3 Using a plastic scribe, pry the base cover off the computer base.

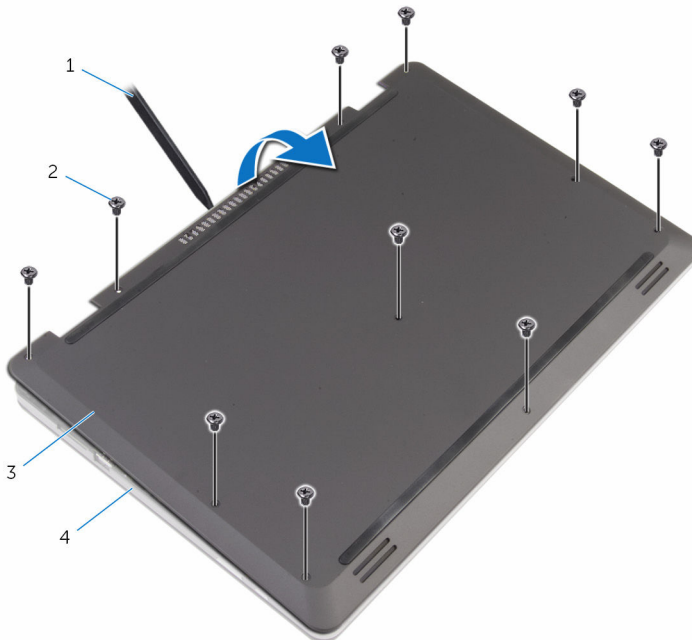

- 1 plastic scribe
- 3 base cover

- 2 screws (10)
- 4 computer base

Replacing the base cover



WARNING: Before working inside your computer, read the safety information that shipped with your computer and follow the steps in [Before working inside your computer](#). After working inside your computer, follow the instructions in [After working inside your computer](#). For more safety best practices, see the Regulatory Compliance home page at www.dell.com/regulatory_compliance.

Procedure

- 1 Slide the tabs on the base cover into the slots on the computer base and snap the base cover into place.
- 2 Replace the screws that secure the base cover to the computer base.

Removing the battery



WARNING: Before working inside your computer, read the safety information that shipped with your computer and follow the steps in [Before working inside your computer](#). After working inside your computer, follow the instructions in [After working inside your computer](#). For more safety best practices, see the Regulatory Compliance home page at www.dell.com/regulatory_compliance.

Prerequisites

Remove the [base cover](#).

Procedure

- 1 Remove the screws that secure the battery to the computer base.
- 2 Remove the hard-drive cable from the routing guides on the battery.

3 Lift the battery off the computer base.

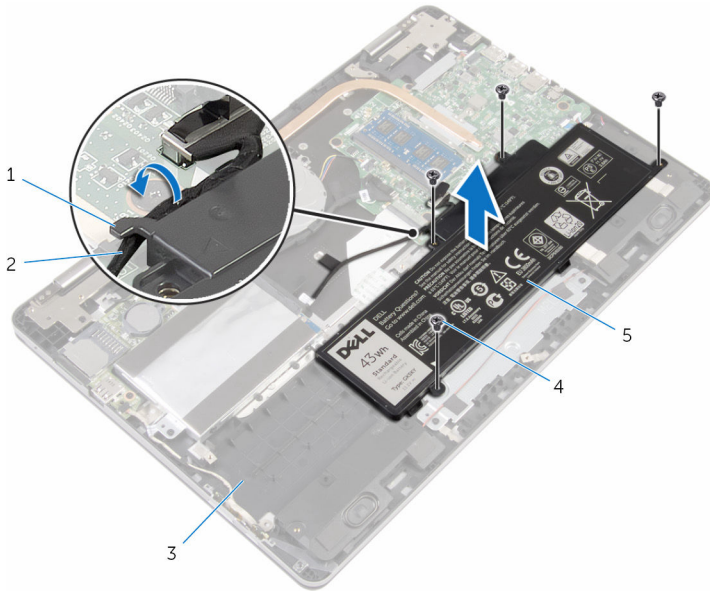

1 routing guide

2 hard-drive cable

3 computer base

4 screws (4)

5 battery

4 Turn the computer over and open the display.

5 Press and hold the power button for 4 seconds to ground the system board.

Replacing the battery



WARNING: Before working inside your computer, read the safety information that shipped with your computer and follow the steps in [Before working inside your computer](#). After working inside your computer, follow the instructions in [After working inside your computer](#). For more safety best practices, see the Regulatory Compliance home page at www.dell.com/regulatory_compliance.

Procedure

- 1 Close the display and turn the computer over.
- 2 Align the screw holes on the battery with the screw holes on the computer base and place the battery on the computer base.
- 3 Replace the screws that secure the battery to the computer base.
- 4 Route the hard-drive cable through the routing guides on the battery.

Post-requisites

Replace the [base cover](#).

Removing the memory module



WARNING: Before working inside your computer, read the safety information that shipped with your computer and follow the steps in [Before working inside your computer](#). After working inside your computer, follow the instructions in [After working inside your computer](#). For more safety best practices, see the Regulatory Compliance home page at www.dell.com/regulatory_compliance.

Prerequisites

- 1 Remove the [base cover](#).
- 2 Remove the [battery](#).

Procedure

- 1 Use your fingertips to carefully spread apart the securing-clips on each end of the memory-module slot until the memory module pops up.

2 Remove the memory module from the memory-module slot.

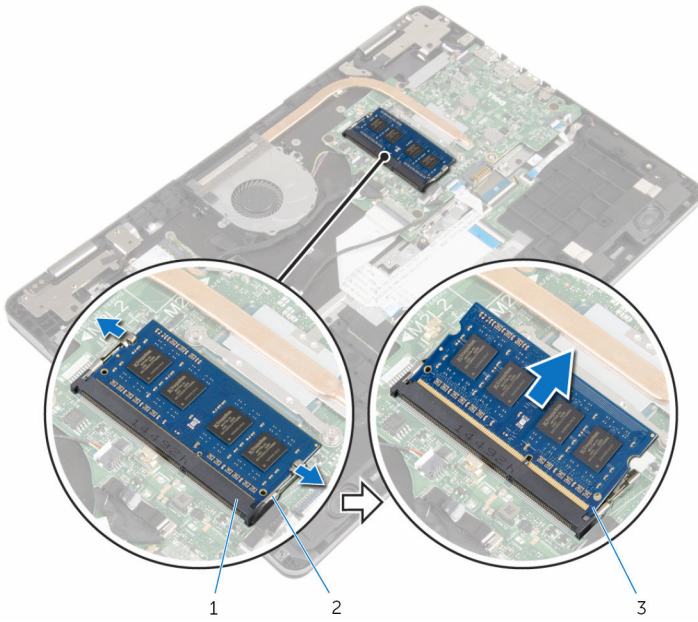

1 memory-module slot

2 securing clips (2)

3 memory module

Replacing the memory module



WARNING: Before working inside your computer, read the safety information that shipped with your computer and follow the steps in [Before working inside your computer](#). After working inside your computer, follow the instructions in [After working inside your computer](#). For more safety best practices, see the Regulatory Compliance home page at www.dell.com/regulatory_compliance.

Procedure

- 1 Align the notch on the memory module with the tab on the memory-module slot.

- Slide the memory module firmly into the slot at an angle and press the memory module down until it clicks into place.

 **NOTE:** If you do not hear the click, remove the memory module and reinstall it.

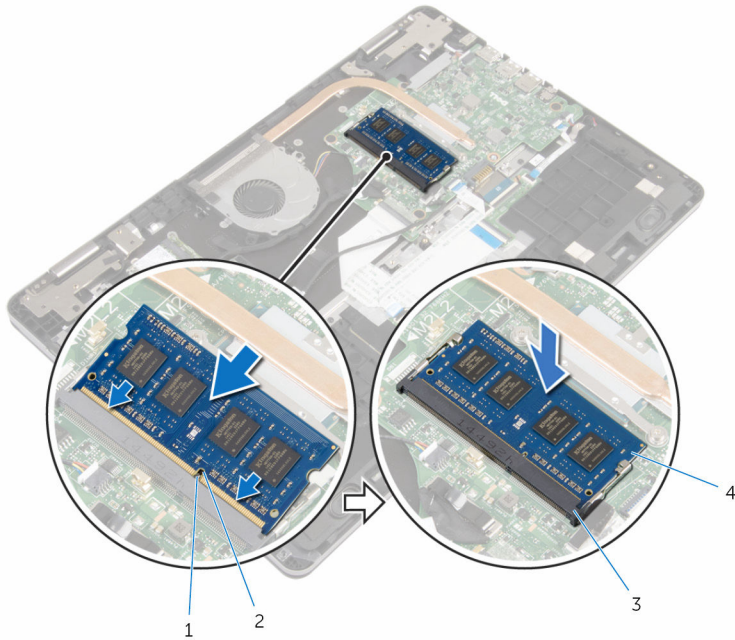

1 tab

2 notch

3 memory-module slot

4 memory module

Post-requisites

- Replace the [battery](#).
- Replace the [base cover](#).

Removing the hard drive

 **WARNING:** Before working inside your computer, read the safety information that shipped with your computer and follow the steps in [Before working inside your computer](#). After working inside your computer, follow the instructions in [After working inside your computer](#). For more safety best practices, see the Regulatory Compliance home page at www.dell.com/regulatory_compliance.

 **CAUTION:** Hard drives are fragile. Exercise care when handling the hard drive.

 **CAUTION:** To avoid data loss, do not remove the hard drive while the computer is in sleep or on state.

Prerequisites

- 1 Remove the [base cover](#).
- 2 Remove the [battery](#).

Procedure

- 1 Using the pull tab, disconnect the hard-drive cable from the system board.
- 2 Peel off the tape that secures the hard-drive cable to the computer base.
- 3 Remove the screws that secure the hard-drive assembly to the computer base.

- 4** Lift the hard-drive assembly along with its cable off the computer base.

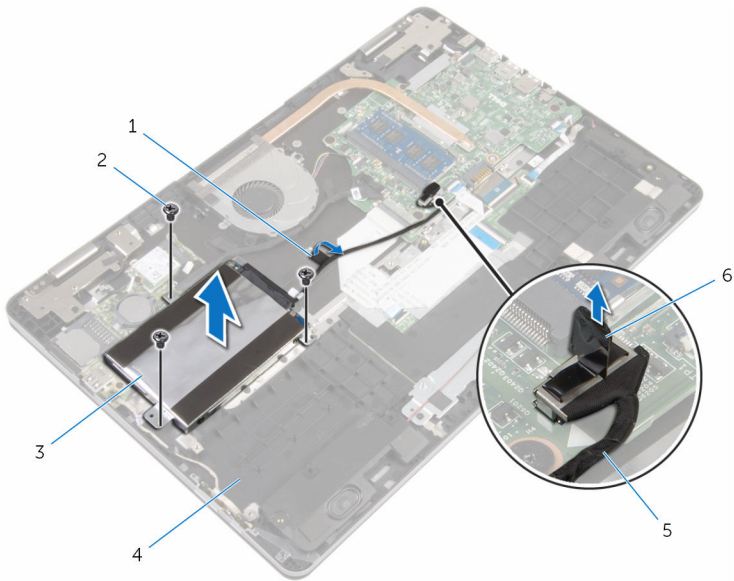

- | | | | |
|---|---------------------|---|---------------|
| 1 | tape | 2 | screws (3) |
| 3 | hard-drive assembly | 4 | computer base |
| 5 | hard-drive cable | 6 | pull tab |

- 5** Disconnect the interposer from the hard-drive assembly.
- 6** Remove the screws that secure the hard-drive bracket to the hard drive.

7 Lift the hard drive off the hard-drive bracket.

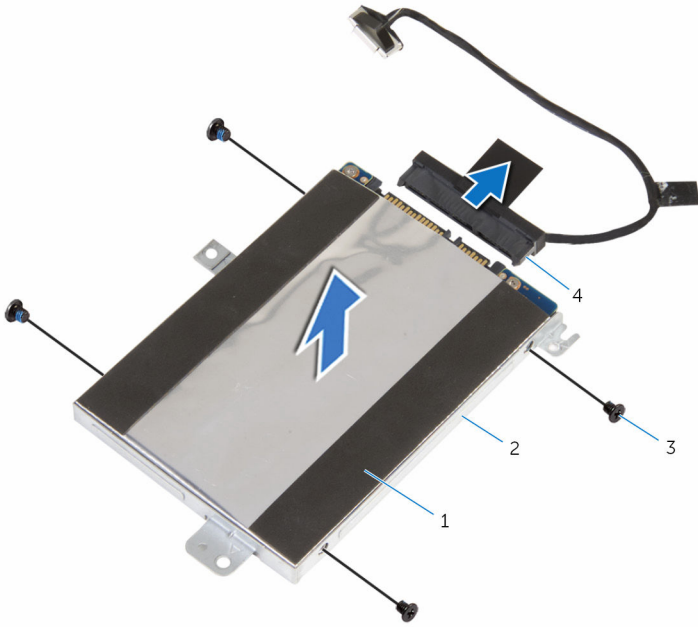



1 hard drive

2 hard-drive bracket

3 screws (4)

4 interposer

Replacing the hard drive

-  **WARNING:** Before working inside your computer, read the safety information that shipped with your computer and follow the steps in [Before working inside your computer](#). After working inside your computer, follow the instructions in [After working inside your computer](#). For more safety best practices, see the Regulatory Compliance home page at www.dell.com/regulatory_compliance.
-  **CAUTION:** Hard drives are fragile. Exercise care when handling the hard drive.



Procedure

- 1 Align the screw holes on the hard-drive bracket with the screw holes on the hard drive.
- 2 Replace the screws that secure the hard-drive bracket to the hard drive.
- 3 Connect the interposer to the hard-drive assembly.
- 4 Align the screw holes on the hard-drive assembly with the screw holes on the computer base.
- 5 Replace the screws that secure the hard-drive assembly to the computer base.
- 6 Connect the hard-drive cable to the system board.
- 7 Adhere the tape that secures the hard-drive cable to the computer base.

Post-requisites

- 1 Replace the [battery](#).
- 2 Replace the [base cover](#).

Removing the coin-cell battery

-  **WARNING:** Before working inside your computer, read the safety information that shipped with your computer and follow the steps in [Before working inside your computer](#). After working inside your computer, follow the instructions in [After working inside your computer](#). For more safety best practices, see the Regulatory Compliance home page at www.dell.com/regulatory_compliance.
-  **CAUTION:** Removing the coin-cell battery resets the BIOS setup program's settings to default. It is recommended that you note the BIOS setup program's settings before removing the coin-cell battery.

Prerequisites

- 1 Remove the [base cover](#).
- 2 Remove the [battery](#).

Procedure

Using a plastic scribe, gently pry the coin-cell battery out of the battery socket on the I/O board.

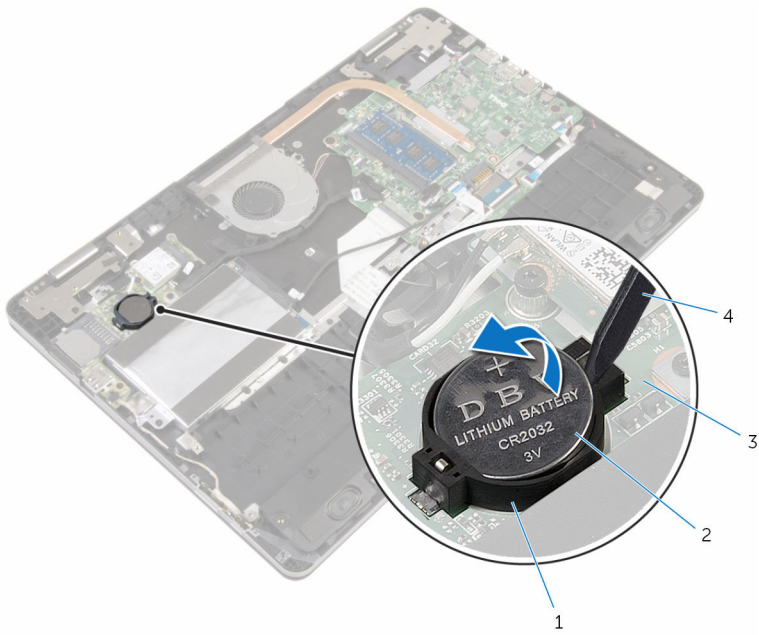

- 1 battery socket
- 3 I/O board

- 2 coin-cell battery
- 4 plastic scribe

Replacing the coin-cell battery



WARNING: Before working inside your computer, read the safety information that shipped with your computer and follow the steps in [Before working inside your computer](#). After working inside your computer, follow the instructions in [After working inside your computer](#). For more safety best practices, see the Regulatory Compliance home page at www.dell.com/regulatory_compliance.

Procedure

With the positive-side facing up, snap the coin-cell battery into the battery socket on the I/O board.

Post-requisites

- 1 Replace the [battery](#).
- 2 Replace the [base cover](#).

Removing the wireless card



WARNING: Before working inside your computer, read the safety information that shipped with your computer and follow the steps in [Before working inside your computer](#). After working inside your computer, follow the instructions in [After working inside your computer](#). For more safety best practices, see the Regulatory Compliance home page at www.dell.com/regulatory_compliance.

Prerequisites

- 1 Remove the [base cover](#).
- 2 Remove the [battery](#).

Procedure

- 1 Disconnect the antenna cables from the wireless card.
- 2 Remove the screw that secures the wireless card to the I/O board.

3 Slide and remove the wireless card from the wireless-card slot.

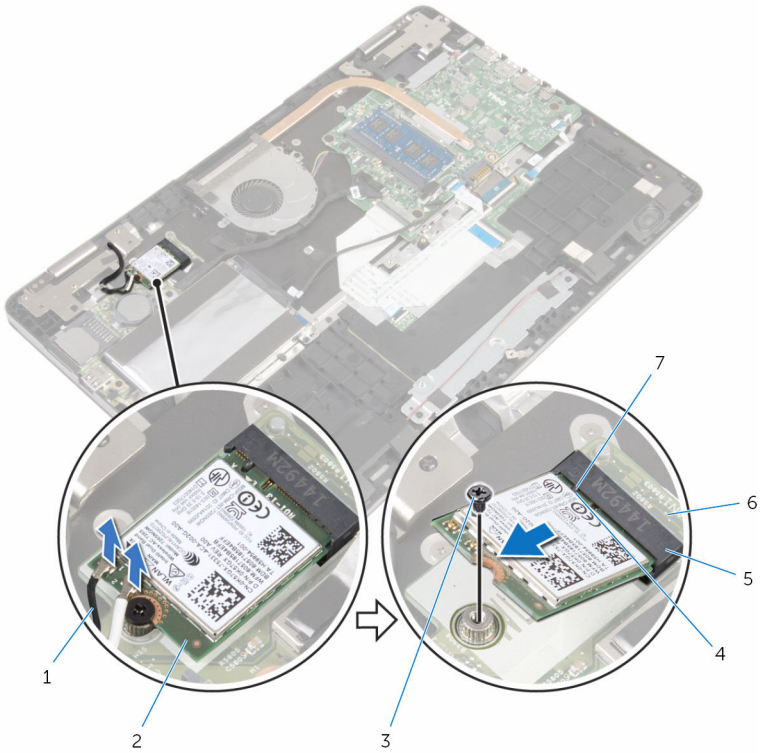

- 1 antenna cables (2)
- 3 screw
- 5 wireless-card slot
- 7 tab

- 2 wireless card
- 4 notch
- 6 I/O board

Replacing the wireless card



WARNING: Before working inside your computer, read the safety information that shipped with your computer and follow the steps in [Before working inside your computer](#). After working inside your computer, follow the instructions in [After working inside your computer](#). For more safety best practices, see the Regulatory Compliance home page at www.dell.com/regulatory_compliance.

Procedure



CAUTION: To avoid damaging the wireless card, do not place any cables under it.

- 1 Align the notch on the wireless card with the tab on the wireless-card slot.
- 2 Insert the wireless card at an angle into the wireless-card slot.
- 3 Align the screw hole on the wireless card with the screw hole on the I/O board.
- 4 Replace the screw that secures the wireless card to the I/O board.

- 5 Connect the antenna cables to the wireless card.

The following table provides the antenna-cable color scheme for the wireless card supported by your computer.

Connectors on the wireless card	Antenna-cable color
Main (white triangle)	White
Auxiliary (black triangle)	Black

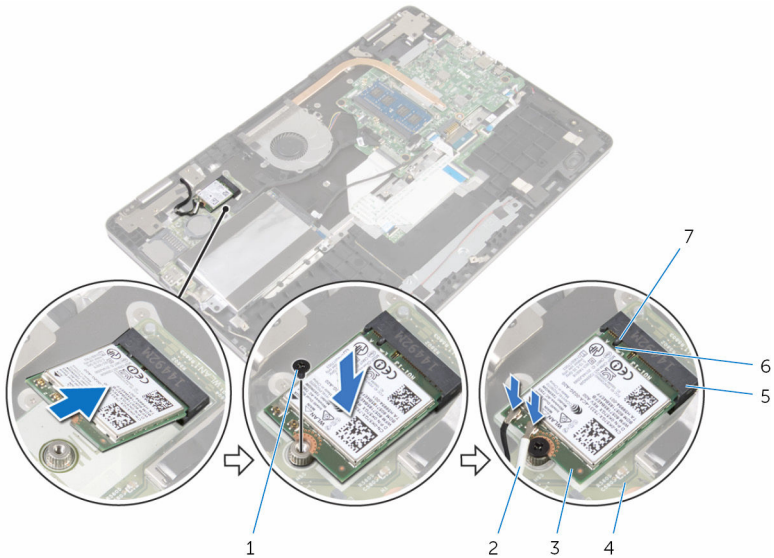

- | | | | |
|---|--------------------|---|--------------------|
| 1 | screw | 2 | antenna cables (2) |
| 3 | wireless card | 4 | I/O board |
| 5 | wireless-card slot | 6 | notch |
| 7 | tab | | |

Post-requisites

- 1 Replace the [battery](#).
- 2 Replace the [base cover](#).

Removing the keyboard daughter-board

 **WARNING:** Before working inside your computer, read the safety information that shipped with your computer and follow the steps in [Before working inside your computer](#). After working inside your computer, follow the instructions in [After working inside your computer](#). For more safety best practices, see the Regulatory Compliance home page at www.dell.com/regulatory_compliance.

Prerequisites

- 1 Remove the [base cover](#).
- 2 Remove the [battery](#).

Procedure

- 1 Lift and hold the touch-pad cable to access the keyboard cable and keyboard-backlight cable latches under it.
- 2 Lift the latches and disconnect the keyboard cables and keyboard-backlight cables from the keyboard daughter-board.

- 3** Using a plastic scribe, gently pry out the keyboard daughter-board from the computer base.

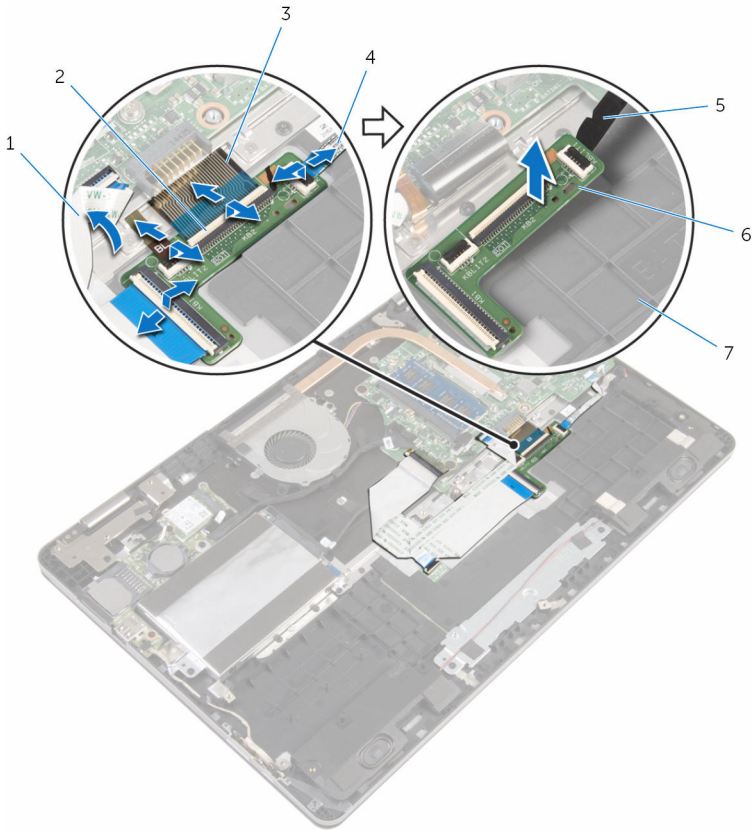

- | | | | |
|---|---------------------|---|-------------------------------|
| 1 | touch-pad cable | 2 | latches (4) |
| 3 | keyboard cables (2) | 4 | keyboard-backlight cables (2) |
| 5 | plastic scribe | 6 | keyboard daughter-board |
| 7 | computer base | | |

Replacing the keyboard daughter-board



WARNING: Before working inside your computer, read the safety information that shipped with your computer and follow the steps in [Before working inside your computer](#). After working inside your computer, follow the instructions in [After working inside your computer](#). For more safety best practices, see the Regulatory Compliance home page at www.dell.com/regulatory_compliance.

Procedure

- 1 Adhere the keyboard daughter-board to the computer base.
- 2 Lift and hold the touch-pad cable to access the keyboard cable and keyboard-backlight cable latches under it.
- 3 Slide the keyboard cables and keyboard-backlight cables into the keyboard daughter-board connectors and press down on the latches to secure the cables.

Post-requisites

- 1 Replace the [battery](#).
- 2 Replace the [base cover](#).

Removing the speakers



WARNING: Before working inside your computer, read the safety information that shipped with your computer and follow the steps in [Before working inside your computer](#). After working inside your computer, follow the instructions in [After working inside your computer](#). For more safety best practices, see the Regulatory Compliance home page at www.dell.com/regulatory_compliance.

Prerequisites

- 1 Remove the [base cover](#).
- 2 Remove the [battery](#).

Procedure

- 1 Disconnect the speaker cable from the system board.
- 2 Remove the speaker cable from the routing guide on the computer base.
- 3 Peel off the tapes that secure the speaker cable to the touch-pad bracket.
- 4 Release the speakers from the tabs on the computer base.

5 Lift the speakers along with its cable off the computer base.

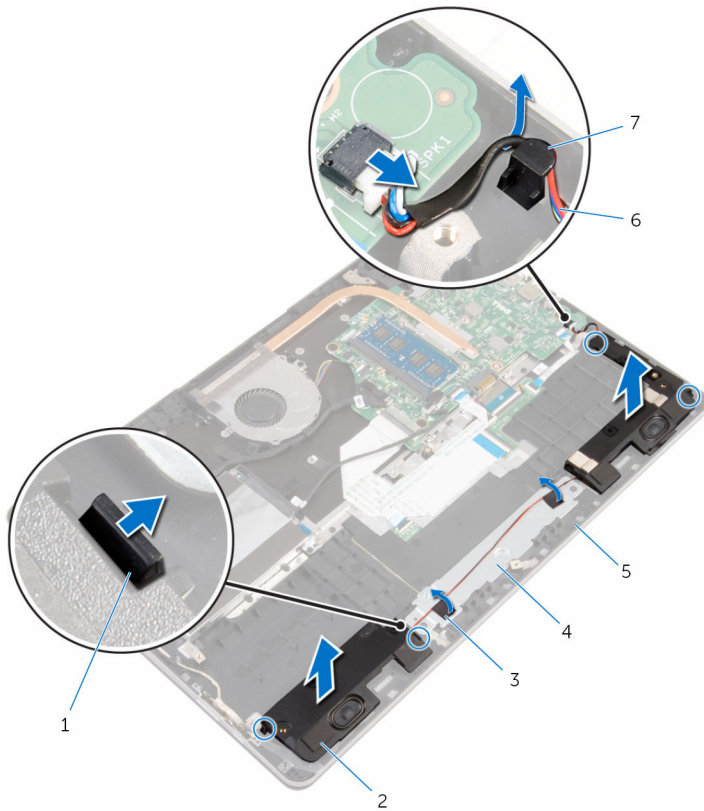

- | | | | |
|---|---------------|---|-------------------|
| 1 | tabs (4) | 2 | speakers (2) |
| 3 | tapes (2) | 4 | touch-pad bracket |
| 5 | computer base | 6 | speaker cable |
| 7 | routing guide | | |

Replacing the speakers



WARNING: Before working inside your computer, read the safety information that shipped with your computer and follow the steps in [Before working inside your computer](#). After working inside your computer, follow the instructions in [After working inside your computer](#). For more safety best practices, see the Regulatory Compliance home page at www.dell.com/regulatory_compliance.

Procedure

- 1 Using the alignment posts, place the speakers in the slots on the computer base and snap the speakers into place.
- 2 Adhere the tapes that secure the speaker cable to the touch-pad bracket.
- 3 Route the speaker cable through the routing guide on the computer base.
- 4 Connect the speaker cable to the system board.

Post-requisites

- 1 Replace the [battery](#).
- 2 Replace the [base cover](#).

Removing the touch pad



WARNING: Before working inside your computer, read the safety information that shipped with your computer and follow the steps in [Before working inside your computer](#). After working inside your computer, follow the instructions in [After working inside your computer](#). For more safety best practices, see the Regulatory Compliance home page at www.dell.com/regulatory_compliance.

Prerequisites

- 1 Remove the [base cover](#).
- 2 Remove the [battery](#).

Procedure

- 1 Using the pull tab, disconnect the hard-drive cable from the system board.
- 2 Lift the latch and disconnect the touch-pad cable from the touch pad.

- 3** Note the touch-pad cable routing and remove the cable from the touch pad.

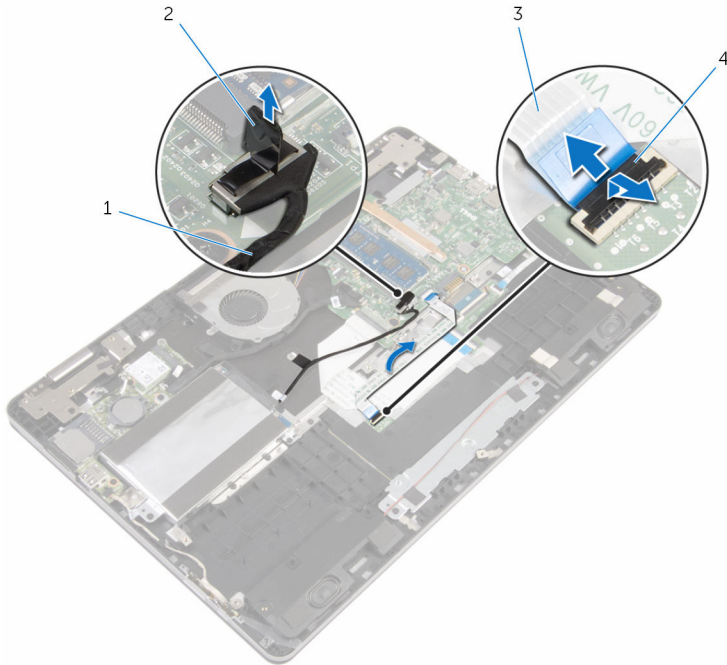

1 hard-drive cable

2 pull tab

3 touch-pad cable

4 latch

- 4** Lift the latch and disconnect the keyboard cable from the keyboard daughter-board.
- 5** Peel off the tape that secures the keyboard cable to the system board.
- 6** Slide the latches and disconnect the keyboard cable from the system board.

7 Peel off the keyboard cable from the computer base.

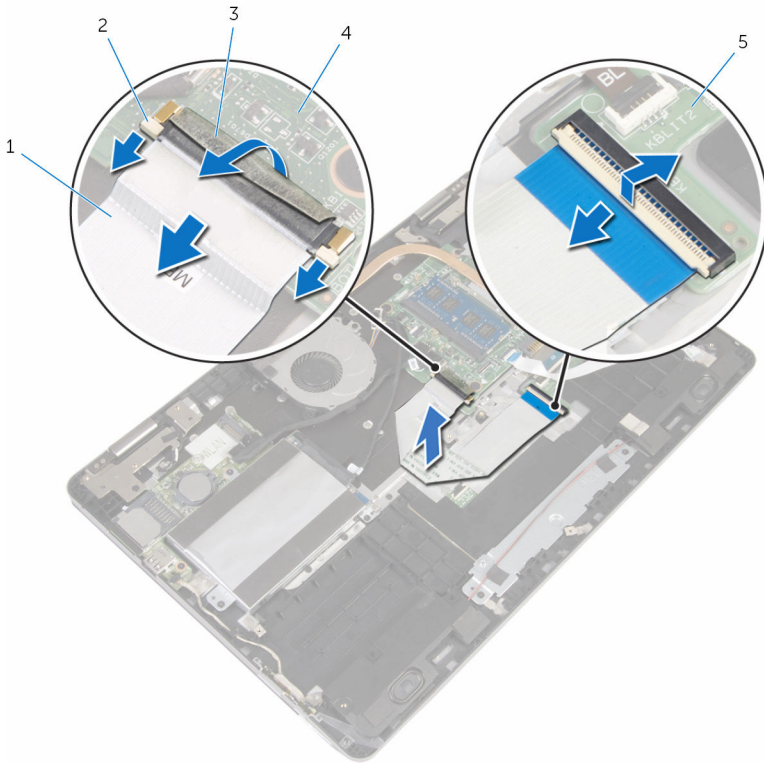

1 keyboard cable

2 latches (3)

3 tape

4 system board

5 keyboard daughter-board

8 Peel off the foil that secures the touch pad to the computer base.

- 9** Lift the left speaker and peel off the tapes that secure the speaker cable to the touch-pad bracket.

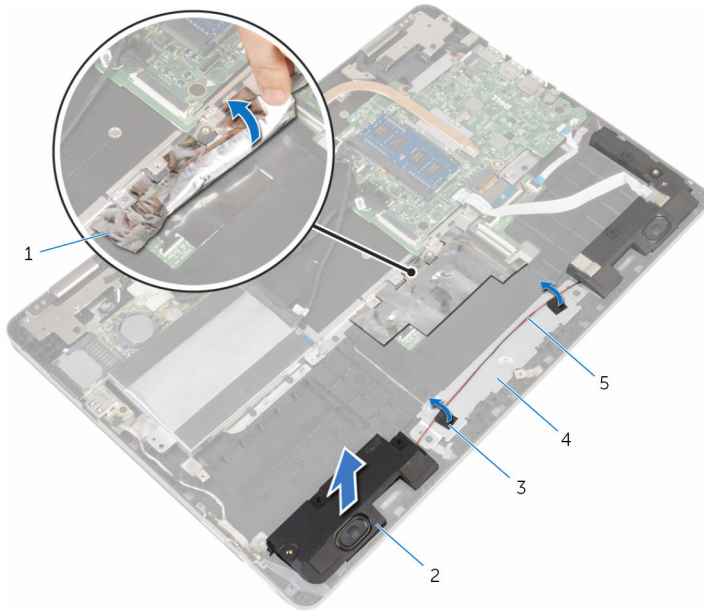

- | | | | |
|---|---------------|---|-------------------|
| 1 | foil | 2 | speaker |
| 3 | tapes (2) | 4 | touch-pad bracket |
| 5 | speaker cable | | |

- 10** Remove the screws that secure the touch-pad bracket to the computer base.

- 11** Lift the touch-pad bracket at an angle and remove it from under the tabs on the computer base.

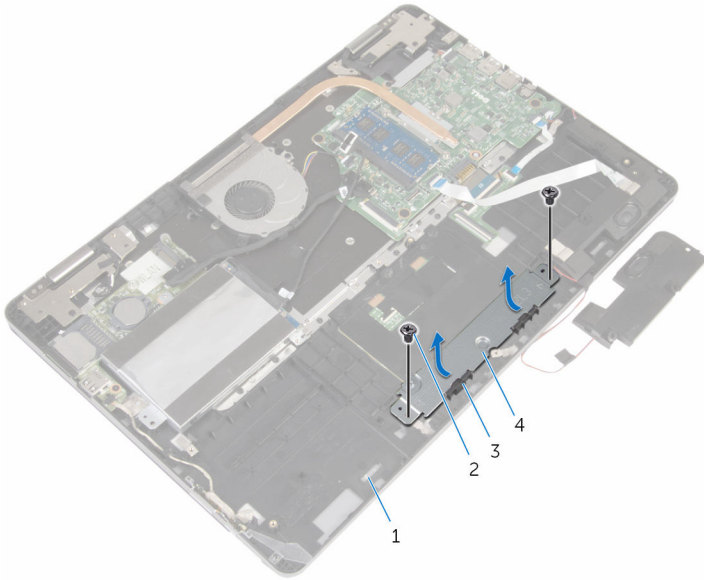

1 computer base

2 screws (2)

3 tabs (2)

4 touch-pad bracket

- 12** Remove the screws that secure the touch pad to the computer base.

13 Lift and slide the touch pad from under the tabs on the computer base.

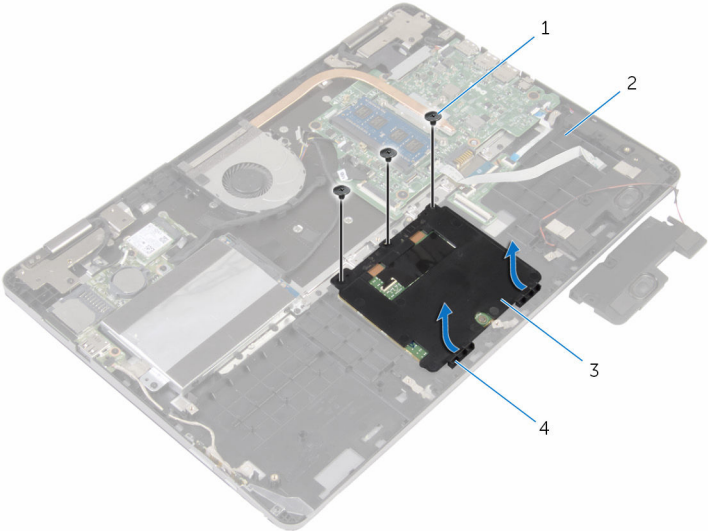

- 1 screws (3)
- 3 touch pad

- 2 computer base
- 4 tabs (2)

Replacing the touch pad



WARNING: Before working inside your computer, read the safety information that shipped with your computer and follow the steps in [Before working inside your computer](#). After working inside your computer, follow the instructions in [After working inside your computer](#). For more safety best practices, see the Regulatory Compliance home page at www.dell.com/regulatory_compliance.

Procedure

- 1 Slide the touch pad under the tabs on the computer base.
- 2 Align the screw holes on the touch pad with the screw holes on the computer base.
- 3 Replace the screws that secure the touch pad to the computer base.
- 4 Slide the tabs on the touch-pad bracket into the slots on the computer base.
- 5 Align the screw holes on the touch-pad bracket with the screw holes on the computer base.
- 6 Replace the screws that secure the touch-pad bracket to the computer base.
- 7 Using the alignment post, place the left speaker on the computer base and snap it into place.
- 8 Adhere the tapes that secure the speaker cable to the touch-pad bracket.
- 9 Adhere the foil to the touch pad.
- 10 Slide the keyboard cable into the keyboard daughter-board connector and press down on the latch to secure the cable.
- 11 Slide the keyboard cable into the system-board connector and slide the latches to secure the cable.
- 12 Adhere the tape to the keyboard-cable connector on the system board.
- 13 Slide the touch-pad cable into the touch-pad connector and press down on the latch to secure the cable.
- 14 Connect the hard-drive cable to the system board.

Post-requisites

- 1 Replace the [battery](#).

2 Replace the [base cover](#).

Removing the fan



WARNING: Before working inside your computer, read the safety information that shipped with your computer and follow the steps in [Before working inside your computer](#). After working inside your computer, follow the instructions in [After working inside your computer](#). For more safety best practices, see the Regulatory Compliance home page at www.dell.com/regulatory_compliance.

Prerequisites

- 1 Remove the [base cover](#).
- 2 Remove the [battery](#).

Procedure

- 1 Using the pull tab, disconnect the I/O-board cable from the system board.

- 2** Peel off the tape and remove the I/O-board cable from the routing guides on the fan.

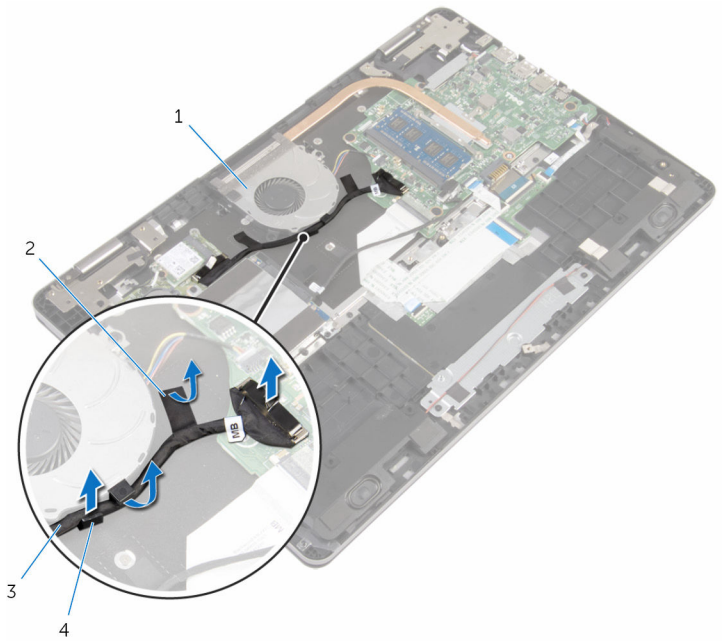

- | | | | |
|---|-----------------|---|---------------|
| 1 | fan | 2 | tape |
| 3 | I/O-board cable | 4 | routing guide |

- 3** Disconnect the fan cable from the system board.
4 Remove the screws that secure the fan to the computer base.

5 Lift the fan along with its cable off the computer base.

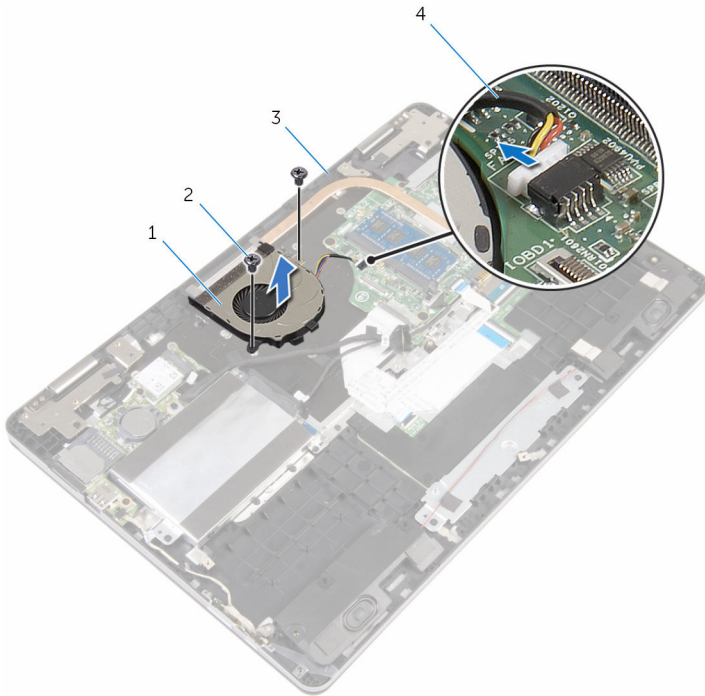

1 fan

2 screws (2)

3 computer base

4 fan cable

Replacing the fan



WARNING: Before working inside your computer, read the safety information that shipped with your computer and follow the steps in [Before working inside your computer](#). After working inside your computer, follow the instructions in [After working inside your computer](#). For more safety best practices, see the Regulatory Compliance home page at www.dell.com/regulatory_compliance.

Procedure

- 1 Align the screw holes on the fan with the screw holes on the computer base.
- 2 Replace the screws that secure the fan to the computer base.
- 3 Connect the fan cable to the system board.
- 4 Route the I/O-board cable through the routing guides on the fan.
- 5 Adhere the I/O-board cable to the computer base and connect the cable to the system board.

Post-requisites

- 1 Replace the [battery](#).
- 2 Replace the [base cover](#).

Removing the heat sink

 **WARNING:** Before working inside your computer, read the safety information that shipped with your computer and follow the steps in [Before working inside your computer](#). After working inside your computer, follow the instructions in [After working inside your computer](#). For more safety best practices, see the Regulatory Compliance home page at www.dell.com/regulatory_compliance.

 **WARNING:** The heat sink may become hot during normal operation. Allow sufficient time for the heat sink to cool before you touch it.

 **CAUTION:** For maximum cooling of the processor, do not touch the heat transfer areas on the heat sink. The oils in your skin can reduce the heat transfer capability of the thermal grease.

Prerequisites

- 1 Remove the [base cover](#).
- 2 Remove the [battery](#).
- 3 Remove the [fan](#).

Procedure

- 1 In sequential order (as indicated on the heat sink), loosen the captive screws that secure the heat sink to the system board.

2 Lift the heat sink off the system board.

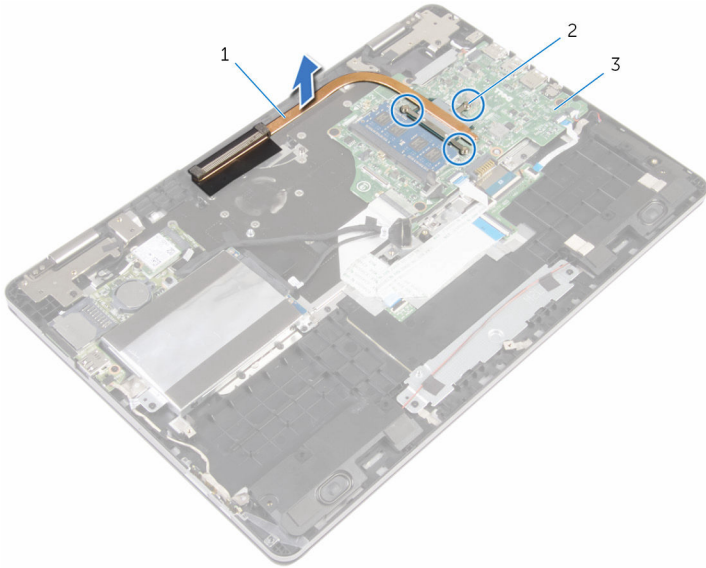

1 heat sink

2 captive screws (3)

3 system board

Replacing the heat sink

 **WARNING:** Before working inside your computer, read the safety information that shipped with your computer and follow the steps in [Before working inside your computer](#). After working inside your computer, follow the instructions in [After working inside your computer](#). For more safety best practices, see the Regulatory Compliance home page at www.dell.com/regulatory_compliance.

 **CAUTION:** Incorrect alignment of the heat sink can damage the system board and processor.

 **NOTE:** The original thermal grease can be reused if the original system board and heat sink are reinstalled together. If either the system board or the heat sink is replaced, use the thermal pad provided in the kit to ensure that thermal conductivity is achieved.

Procedure

- 1 Align the screw holes on the heat sink with the screw holes on the system board.
- 2 In sequential order (indicated on the heat sink), tighten the captive screws that secure the heat sink to the system board.

Post-requisites

- 1 Replace the [fan](#).
- 2 Replace the [battery](#).
- 3 Replace the [base cover](#).

Removing the power-adapter port

 **WARNING:** Before working inside your computer, read the safety information that shipped with your computer and follow the steps in [Before working inside your computer](#). After working inside your computer, follow the instructions in [After working inside your computer](#). For more safety best practices, see the Regulatory Compliance home page at www.dell.com/regulatory_compliance.

Prerequisites

- 1 Remove the [base cover](#).
- 2 Remove the [battery](#).

Procedure

- 1 Disconnect the power-adapter port cable from the system board.
- 2 Remove the screw that secures the power-adapter port to the computer base.

3 Lift the power-adapter port along with its cable off the computer base.

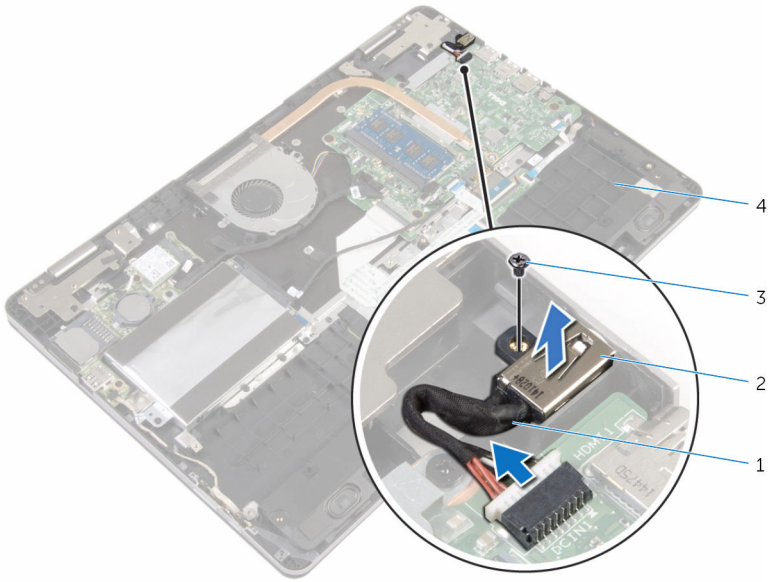

1 power-adapter port cable

2 power-adapter port

3 screw

4 computer base

Replacing the power-adapter port

 **WARNING:** Before working inside your computer, read the safety information that shipped with your computer and follow the steps in [Before working inside your computer](#). After working inside your computer, follow the instructions in [After working inside your computer](#). For more safety best practices, see the Regulatory Compliance home page at www.dell.com/regulatory_compliance.

Procedure

- 1 Slide the power-adapter port into the slot on the computer base.
- 2 Replace the screw that secures the power-adapter port to the computer base.
- 3 Connect the power-adapter port cable to the system board.

Post-requisites

- 1 Replace the [battery](#).
- 2 Replace the [base cover](#).

Removing the power and volume-buttons board



WARNING: Before working inside your computer, read the safety information that shipped with your computer and follow the steps in [Before working inside your computer](#). After working inside your computer, follow the instructions in [After working inside your computer](#). For more safety best practices, see the Regulatory Compliance home page at www.dell.com/regulatory_compliance.

Prerequisites

- 1 Remove the [base cover](#).
- 2 Remove the [battery](#).
- 3 Follow the procedure from step 1 to step 4 in "[Removing the hard drive](#)".

Procedure

- 1 Peel off the tape that secures the power and volume-buttons board cable to the computer base.
- 2 Disconnect the power and volume-buttons board cable from the I/O board.

- 3 Remove the power and volume-buttons board cable from the routing guide on the computer base.

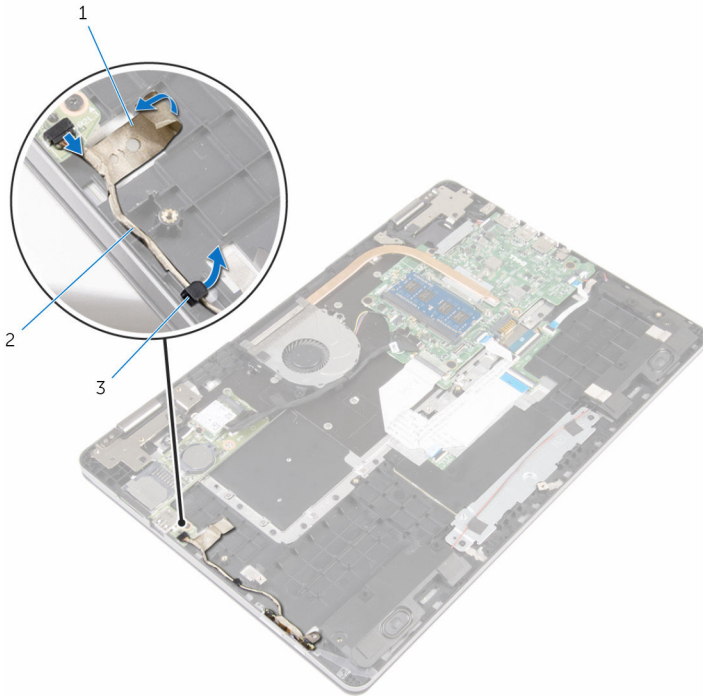

1 tape

2 power and volume-
buttons board cable

3 routing guide

- 4 Peel off the tape that secures the power and volume-buttons board to the computer base.
- 5 Slide and remove the power and volume-buttons board from under the tabs on the computer base.

- 6 Lift the power and volume-buttons board along with its cable off the computer base.

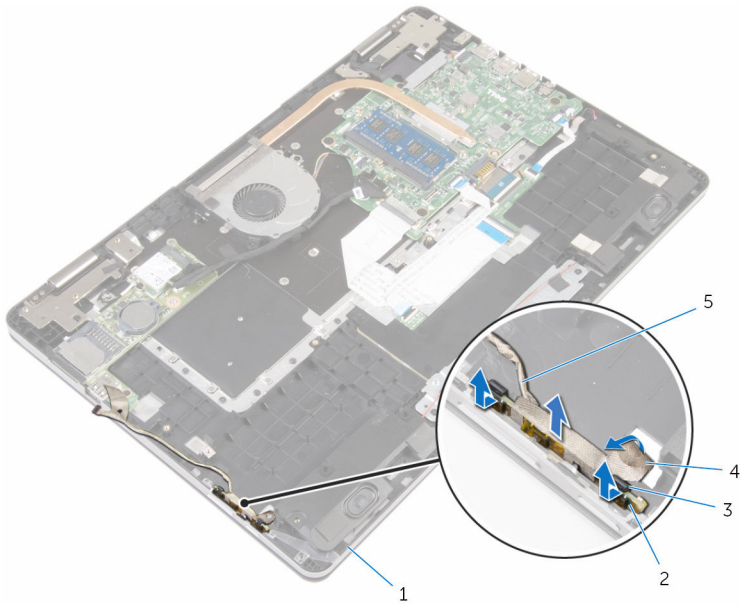

- | | | | |
|---|--------------------------------------|---|--------------------------------|
| 1 | computer base | 2 | power and volume-buttons board |
| 3 | tabs (2) | 4 | tape |
| 5 | power and volume-buttons board cable | | |

Replacing the power and volume-buttons board



WARNING: Before working inside your computer, read the safety information that shipped with your computer and follow the steps in [Before working inside your computer](#). After working inside your computer, follow the instructions in [After working inside your computer](#). For more safety best practices, see the Regulatory Compliance home page at www.dell.com/regulatory_compliance.

Procedure

- 1 Slide the power and volume-buttons board into the slot on the computer base and snap the power and volume-buttons board into place.
- 2 Adhere the tape that secures the power and volume-buttons board to the computer base.
- 3 Route the power and volume-buttons board cable through the routing guide on the computer base.
- 4 Connect the power and volume-buttons board cable to the I/O board.
- 5 Adhere the tape that secures the power and volume-buttons board cable to the computer base.

Post-requisites

- 1 Follow the procedure from step 4 to step 7 in "[Replacing the hard drive](#)".
- 2 Replace the [battery](#).
- 3 Replace the [base cover](#).

Removing the I/O board



WARNING: Before working inside your computer, read the safety information that shipped with your computer and follow the steps in [Before working inside your computer](#). After working inside your computer, follow the instructions in [After working inside your computer](#). For more safety best practices, see the Regulatory Compliance home page at www.dell.com/regulatory_compliance.

Prerequisites

- 1 Remove the [base cover](#).
- 2 Remove the [battery](#).
- 3 Follow the procedure from step 1 to step 4 in "[Removing the hard drive](#)".
- 4 Remove the [wireless card](#).
- 5 Remove the [coin-cell battery](#).

Procedure

- 1 Using the pull tab, disconnect the I/O-board cable from the I/O board.
- 2 Disconnect the power and volume-buttons board cable from the I/O board.
- 3 Remove the screw that secures the I/O board to the computer base.

4 Lift the I/O board off the computer base.

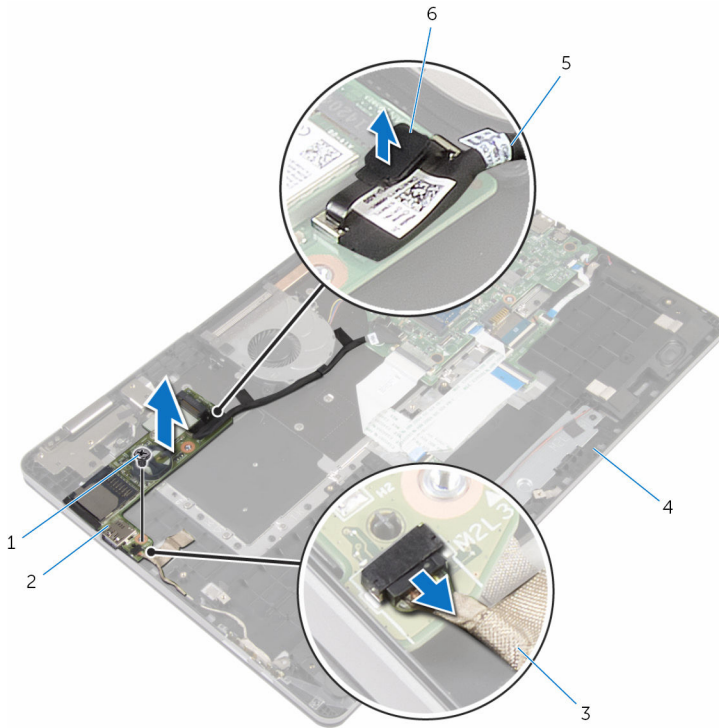

1 screw

2 I/O-board

3 power and volume-board cable

4 computer base

5 I/O-board cable

6 pull tab

Replacing the I/O board



WARNING: Before working inside your computer, read the safety information that shipped with your computer and follow the steps in [Before working inside your computer](#). After working inside your computer, follow the instructions in [After working inside your computer](#). For more safety best practices, see the Regulatory Compliance home page at www.dell.com/regulatory_compliance.

Procedure

- 1 Using the alignment posts, place the I/O board on the computer base.
- 2 Align the screw holes on the I/O board with the screw holes on the computer base.
- 3 Replace the screw that secures the I/O board to the computer base.
- 4 Connect the power and volume-buttons board cable to the I/O board.
- 5 Connect the I/O-board cable to the I/O board.

Post-requisites

- 1 Replace the [coin-cell battery](#).
- 2 Replace the [wireless card](#).
- 3 Follow the procedure from step 4 to step 7 in "[Replacing the hard drive](#)".
- 4 Replace the [battery](#).
- 5 Replace the [base cover](#).

Removing the display assembly



WARNING: Before working inside your computer, read the safety information that shipped with your computer and follow the steps in [Before working inside your computer](#). After working inside your computer, follow the instructions in [After working inside your computer](#). For more safety best practices, see the Regulatory Compliance home page at www.dell.com/regulatory_compliance.

Prerequisites

- 1 Remove the [base cover](#).
- 2 Remove the [battery](#).

Procedure

- 1 Disconnect the antenna cables from the wireless card.
- 2 Peel off the tape that secures the antenna cables to the display hinge.
- 3 Remove the antenna cables from the routing guides on the computer base.
- 4 Remove the screws that secure the display-cable bracket to the system board.
- 5 Lift the display-cable bracket off the system board.
- 6 Using the pull tab, disconnect the display cable from the system board.
- 7 Peel off the tape that secures the Windows-button board cable to the system board.
- 8 Lift the latch and disconnect the Windows-button board cable from the system board.

9 Peel off the tape that secures the display cable to the display hinge.

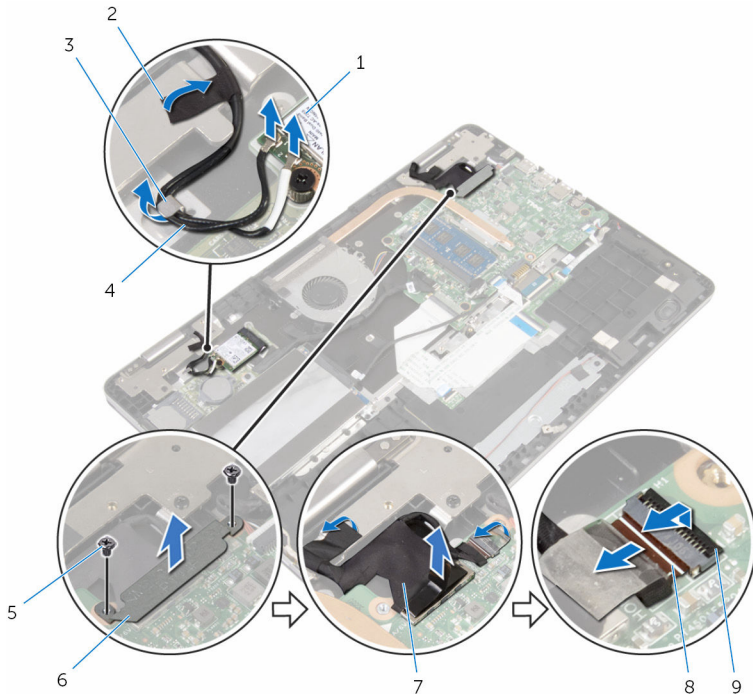

1 wireless card

3 routing guide

5 screws (2)

7 display cable

9 latch

2 tapes (2)

4 antenna cables (2)

6 display-cable bracket

8 Windows-button board cable

10 Turn the computer over and open the display to 180-degree angle.

⚠ CAUTION: Place the computer on a soft and clean surface to avoid scratching the display.

11 Place the computer face down on a clean and flat surface.

12 Remove the screws that secure the display assembly to the computer base.

13 Lift the display assembly off the computer base.

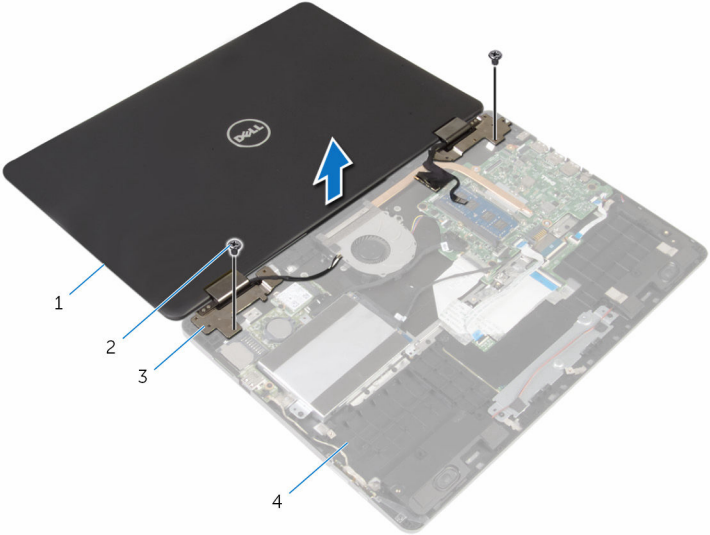

- 1 display assembly
- 3 display hinges (2)

- 2 screws (2)
- 4 computer base

Replacing the display assembly

 **WARNING:** Before working inside your computer, read the safety information that shipped with your computer and follow the steps in [Before working inside your computer](#). After working inside your computer, follow the instructions in [After working inside your computer](#). For more safety best practices, see the Regulatory Compliance home page at www.dell.com/regulatory_compliance.

Procedure

 **CAUTION:** Place the computer on a soft and clean surface to avoid scratching the display.

- 1 With the display screen facing down, align the screw holes on the display hinges with the screw holes on the computer base.
- 2 Replace the screws that secure the display assembly to the computer base.
- 3 Turn the computer over and close the display.
- 4 Turn the computer over.
- 5 Slide the Windows button-board cable into the system-board connector and press down on the latch to secure the cable.
- 6 Adhere the tape to the Windows button-board connector.
- 7 Connect the display cable to the system board.
- 8 Align the screw holes on the display-cable bracket with the screw holes on the system board.
- 9 Replace the screws that secure the display-cable bracket to the system board.
- 10 Adhere the tape that secures the display cable to the display hinge.
- 11 Route the antenna cables through the routing guides on the computer base and adhere the tape that secures the antenna cables to the display hinge.
- 12 Connect the antenna cables to the wireless card. See "[Replacing the wireless card](#)".

Post-requisites

- 1 Replace the [battery](#).

2 Replace the [base cover](#).

Removing the system board



WARNING: Before working inside your computer, read the safety information that shipped with your computer and follow the steps in [Before working inside your computer](#). After working inside your computer, follow the instructions in [After working inside your computer](#). For more safety best practices, see the Regulatory Compliance home page at www.dell.com/regulatory_compliance.



NOTE: Your computer's Service Tag is stored in the system board. You must enter the Service Tag in the BIOS setup program after you replace the system board.



NOTE: Replacing the system board removes any changes you have made to the BIOS using the BIOS setup program. You must make the desired changes again after you replace the system board.



NOTE: Before disconnecting the cables from the system board, note the location of the connectors so that you can reconnect the cables correctly after you replace the system board.

Prerequisites

- 1 Remove the [base cover](#).
- 2 Remove the [battery](#).
- 3 Remove the [memory module](#).
- 4 Remove the [fan](#).
- 5 Remove the [heat sink](#).

Procedure

- 1 Remove the screws that secure the display-cable bracket to the system board.
- 2 Lift the display-cable bracket off the system board.
- 3 Using the pull tab, disconnect the display cable from the system board.
- 4 Peel off the tape that secures the Windows-button board cable to the system board.
- 5 Lift the latches and disconnect the Windows-button board cable and keyboard-backlight cable from the system board.

6 Disconnect the speaker cable and the power-adapter port cable from the system board.

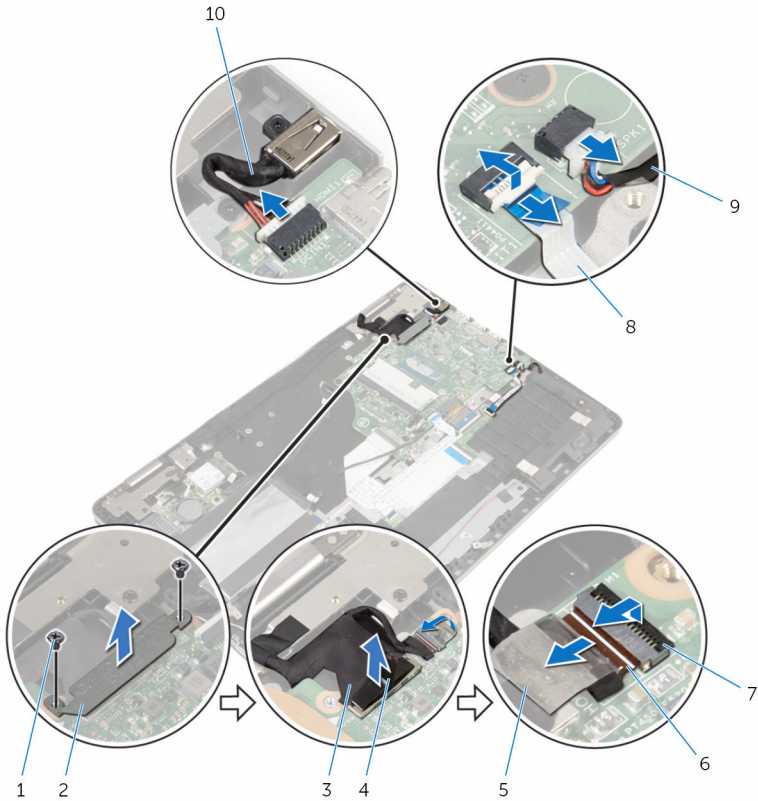

1 screws (2)

3 display cable

5 tape

7 latches (2)

9 speaker cable

2 display-cable bracket

4 pull tab

6 Windows-button board cable

8 keyboard-backlight cable

10 power-adapter port cable

7 Using the pull tab, disconnect the hard-drive cable from the system board.

- 8 Lift the latch and disconnect the touch-pad cable from the system board.
- 9 Peel off the tape, slide the latches, and disconnect the keyboard cable from the system board.

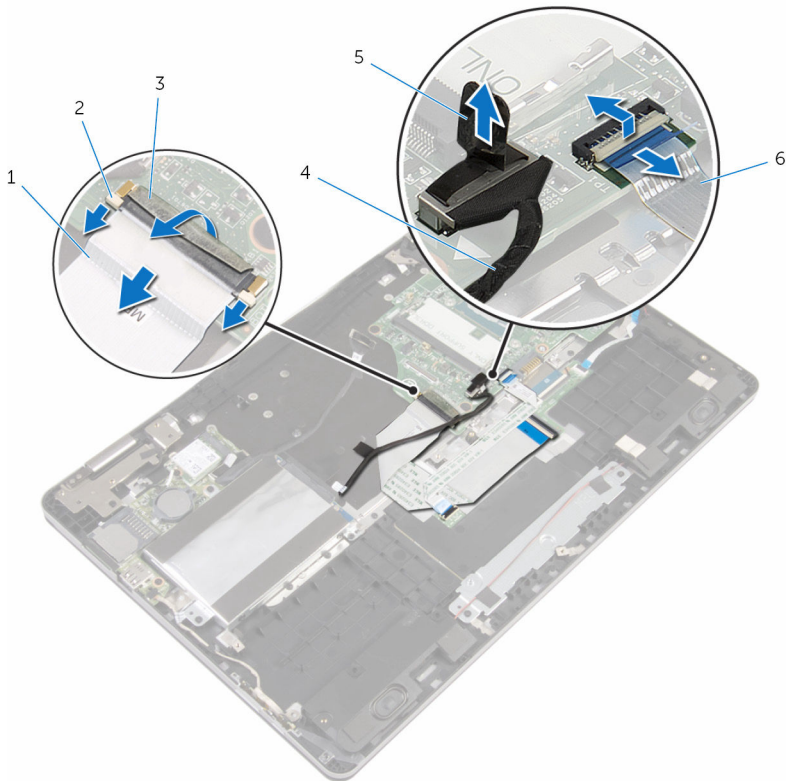

1 keyboard cable

2 latches (3)

3 tape

4 hard-drive cable

5 pull tab

6 touch-pad cable

- 10 Remove the screws that secure the system board to the computer base.

11 Lift the system board off the computer base.

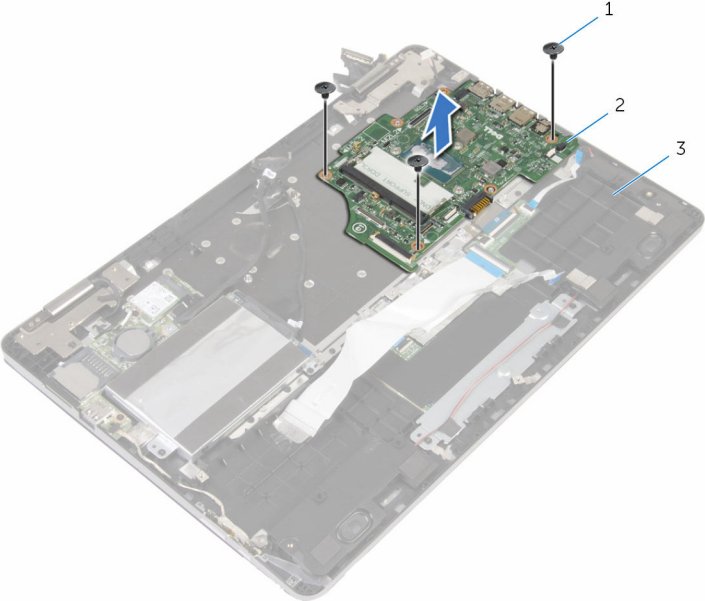

1 screws (3)

2 system board

3 computer base

Replacing the system board



WARNING: Before working inside your computer, read the safety information that shipped with your computer and follow the steps in [Before working inside your computer](#). After working inside your computer, follow the instructions in [After working inside your computer](#). For more safety best practices, see the Regulatory Compliance home page at www.dell.com/regulatory_compliance.



NOTE: Your computer's Service Tag is stored in the system board. You must enter the Service Tag in the BIOS setup program after you replace the system board.



NOTE: Replacing the system board removes any changes you have made to the BIOS using the BIOS setup program. You must make the desired changes again after you replace the system board.

Procedure

- 1 Align the screw holes on the system board with the screw holes on the computer base.
- 2 Replace the screws that secure the system board to the computer base.
- 3 Slide the keyboard cable into the system-board connector and slide the latches to secure the cable.
- 4 Adhere the tape to the keyboard-cable connector on the system board.
- 5 Slide the touch-pad cable and keyboard-backlight cable into the system-board connectors and press down on the latches to secure the cable.
- 6 Connect the hard-drive cable, power-adaptor port cable, and speaker cable to the system board.
- 7 Slide the Windows-button board cable into the system-board connector and press down on the latch to secure the cable.
- 8 Adhere the tape to the Windows-button board connector.
- 9 Connect the display cable to the system board.
- 10 Align the screw holes on the display-cable bracket with the screw holes on the system board.
- 11 Replace the screws that secure the display-cable bracket to the system board.

Post-requisites

- 1 Replace the [heat sink](#).
- 2 Replace the [fan](#).
- 3 Replace the [memory module](#).
- 4 Replace the [battery](#).
- 5 Replace the [base cover](#).

Entering the Service Tag in the BIOS setup program

- 1 Turn on the computer.
- 2 Press F2 when the DELL logo is displayed to enter the BIOS setup program.
- 3 Navigate to the **Main** tab and enter the Service Tag in the **Service Tag Input** field.

Removing the keyboard



WARNING: Before working inside your computer, read the safety information that shipped with your computer and follow the steps in [Before working inside your computer](#). After working inside your computer, follow the instructions in [After working inside your computer](#). For more safety best practices, see the Regulatory Compliance home page at www.dell.com/regulatory_compliance.

Prerequisites

- 1 Remove the [base cover](#).
- 2 Remove the [battery](#).
- 3 Remove the [memory module](#).
- 4 Remove the [wireless card](#).
- 5 Remove the [coin-cell battery](#).
- 6 Follow the procedure from step 1 to step 4 in "[Removing the hard drive](#)".
- 7 Remove the [fan](#).
- 8 Remove the [heat sink](#).
- 9 Remove the [I/O board](#).
- 10 Remove the [display assembly](#).
- 11 Remove the [system board](#).

Procedure

- 1 Lift the latches and disconnect the keyboard cable and keyboard-backlight cable from the keyboard daughter-board.
- 2 Remove the screws that secure the keyboard assembly to the computer base.

3 Lift the keyboard assembly off the computer base.

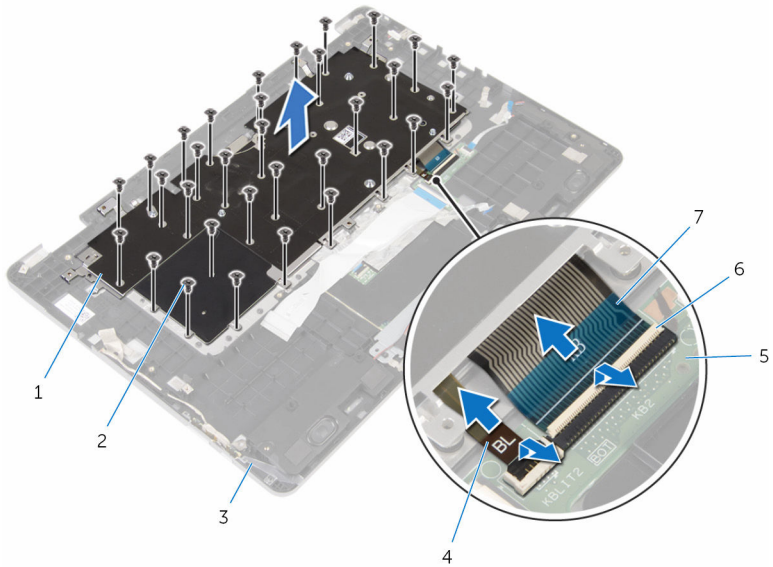

1 keyboard assembly

2 screws (32)

3 computer base

4 keyboard-backlight cable

5 keyboard daughter-board

6 latches (2)

7 keyboard cable

4 Turn the keyboard assembly over and place it on a clean and flat surface.

5 Pry the keyboard off the keyboard bracket.

- 6 Lift the keyboard along with its cables off the keyboard bracket.

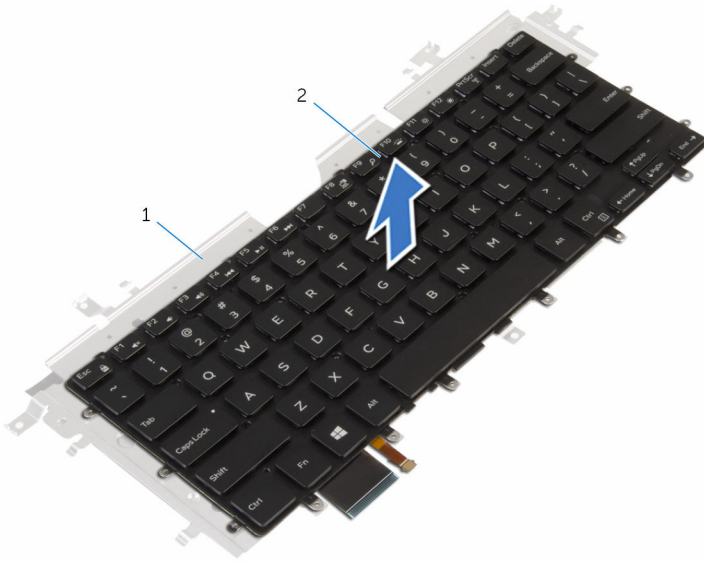

1 keyboard bracket

2 keyboard

Replacing the keyboard



WARNING: Before working inside your computer, read the safety information that shipped with your computer and follow the steps in [Before working inside your computer](#). After working inside your computer, follow the instructions in [After working inside your computer](#). For more safety best practices, see the Regulatory Compliance home page at www.dell.com/regulatory_compliance.

Procedure

- 1 Adhere the keyboard to the keyboard bracket.
- 2 Turn the keyboard assembly over.
- 3 Align the screw holes on the keyboard assembly with the screw holes on the computer base.
- 4 Replace the screws that secure the keyboard assembly to the computer base.
- 5 Slide the keyboard cable and keyboard-backlight cable into the keyboard daughter-board connectors and press down on the latches to secure the cables.

Post-requisites

- 1 Replace the [system board](#).
- 2 Replace the [display assembly](#).
- 3 Replace the [I/O board](#).
- 4 Replace the [heat sink](#).
- 5 Replace the [fan](#).
- 6 Follow the procedure from step 4 to step 7 in "[Replacing the hard drive](#)".
- 7 Replace the [coin-cell battery](#).
- 8 Replace the [wireless card](#).
- 9 Replace the [memory module](#).
- 10 Replace the [battery](#).
- 11 Replace the [base cover](#).

Removing the computer base



WARNING: Before working inside your computer, read the safety information that shipped with your computer and follow the steps in [Before working inside your computer](#). After working inside your computer, follow the instructions in [After working inside your computer](#). For more safety best practices, see the Regulatory Compliance home page at www.dell.com/regulatory_compliance.

Prerequisites

- 1 Remove the [base cover](#).
- 2 Remove the [battery](#).
- 3 Remove the [memory module](#).
- 4 Remove the [wireless card](#).
- 5 Remove the [coin-cell battery](#).
- 6 Follow the procedure from step 1 to step 4 in "[Removing the hard drive](#)".
- 7 Remove the [keyboard daughter-board](#).
- 8 Remove the [touch pad](#).
- 9 Remove the [fan](#).
- 10 Remove the [heat sink](#).
- 11 Remove the [I/O board](#).
- 12 Remove the [power and volume-buttons board](#).
- 13 Remove the [speakers](#).
- 14 Remove the [display assembly](#).
- 15 Remove the [power-adapter port](#).
- 16 Remove the [system board](#).
- 17 Remove the [keyboard](#).

Procedure

After performing the steps in prerequisites we are left with the computer base.

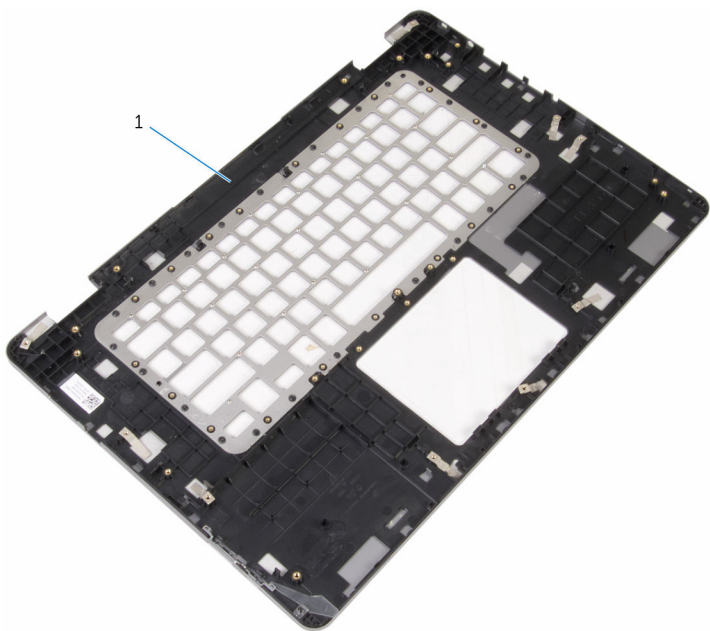

1 computer base

Replacing the computer base



WARNING: Before working inside your computer, read the safety information that shipped with your computer and follow the steps in [Before working inside your computer](#). After working inside your computer, follow the instructions in [After working inside your computer](#). For more safety best practices, see the Regulatory Compliance home page at www.dell.com/regulatory_compliance.

Procedure

Place the computer base on a clean and flat surface.

Post-requisites

- 1 Replace the [keyboard](#).
- 2 Replace the [system board](#).
- 3 Replace the [power-adapter port](#).
- 4 Replace the [display assembly](#).
- 5 Replace the [speakers](#).
- 6 Replace the [power and volume-buttons board](#).
- 7 Replace the [I/O board](#).
- 8 Replace the [heat sink](#).
- 9 Replace the [fan](#).
- 10 Replace the [touch pad](#).
- 11 Replace the [keyboard daughter-board](#).
- 12 Follow the procedure from step 4 to step 7 in "[Replacing the hard drive](#)".
- 13 Replace the [coin-cell battery](#).
- 14 Replace the [wireless card](#).
- 15 Replace the [memory module](#).
- 16 Replace the [battery](#).
- 17 Replace the [base cover](#).

Flashing the BIOS

You may need to flash (update) the BIOS when an update is available or when you replace the system board. To flash the BIOS:

- 1 Turn on the computer.
- 2 Go to **www.dell.com/support**.
- 3 Click **Product Support**, enter the Service Tag of your computer and click **Submit**.
 **NOTE:** If you do not have the Service Tag, use the auto-detect feature or manually browse for your computer model.
- 4 Click **Drivers & downloads**.
- 5 Select the operating system installed on your computer.
- 6 Scroll down the page and expand **BIOS**.
- 7 Click **Download File** to download the latest version of the BIOS for your computer.
- 8 Save the file and, once the download is complete, navigate to the folder where you saved the BIOS update file.
- 9 Double-click the BIOS update file icon and follow the instructions on the screen.

Getting help and contacting Dell

Self-help resources

You can get information and help on Dell products and services using these self-help resources:

Information about Dell products and services

www.dell.com

Windows 8.1 and Windows 10

Dell Help & Support app



Windows 10

Get started app



Windows 8.1

Help + Tips app



Accessing help in Windows 8, Windows 8.1, and Windows 10

In Windows search, type **Help and Support**, and press **Enter**.

Accessing help in Windows 7

Click **Start** → **Help and Support**.

Online help for operating system

www.dell.com/support/windows
www.dell.com/support/linux

Troubleshooting information, user manuals, setup instructions, product specifications, technical help blogs, drivers, software updates, and so on

www.dell.com/support

Learn about your operating system, setting up and using your computer, data backup, diagnostics, and so on.

See *Me and My Dell* at www.dell.com/support/manuals.

Contacting Dell

To contact Dell for sales, technical support, or customer service issues, see www.dell.com/contactdell.



NOTE: Availability varies by country and product, and some services may not be available in your country.



NOTE: If you do not have an active internet connection, you can find contact information on your purchase invoice, packing slip, bill, or Dell product catalog.